



Bombas IS Industrial Service HIERRO

Acople universal

IU 040x025x200

Características de la bomba

Tipo de bomba	Acoplamiento	Tipo de impulsor	Temperatura máx. líquido	Sello Mecánico	Velocidad (rpm)		
Centrífuga	Universal	Cerrado Balancado ISO (G.6.3)	90 °	1 1/4" Tipo 12	3600 rpm		
Modelo	Ref.	Ø Succión	Ø Descarga	H máx. (mca) *	Q máx. (gpm) **	Etapas	Peso Kg
IU 040x025x200	1K0401	40 mm	25mm	92	101	1	45,0

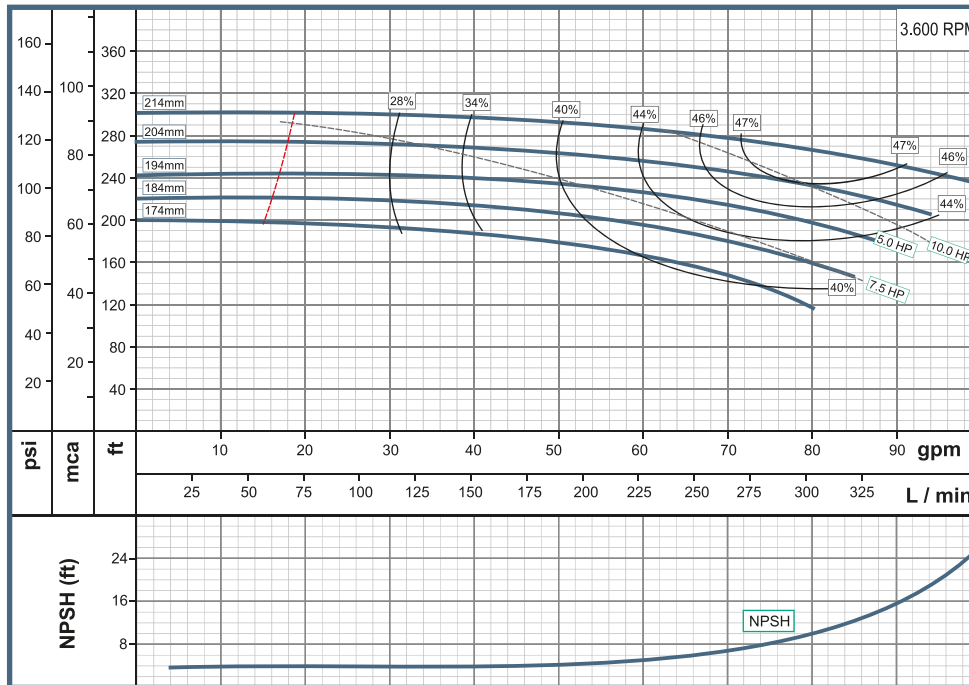

Aplicaciones

- * Suministro de Agua
- * Riego
- * Drenaje
- * Sistema de calentamiento
- * Sistema de Aire Condicionado
- * Servicio de agua
- * Agua Caliente

FLANGE		PUMP DIMENSIONS				SUPPORT DIMENSIONS					HOLES FOR		FLANGE DN1			FLANGE DN2			SHAFT END			
DN1	DN2	A	F	H1	H2	M1	M2	N1	N2	N3	W	S1	S2	Z	No	DIAM	Z	No	DIAM	U	X	Y
40	25	80	360	160	180	125	95	320	250	110	249,5	14	14	110	4	18	85	4	14	24	8	27

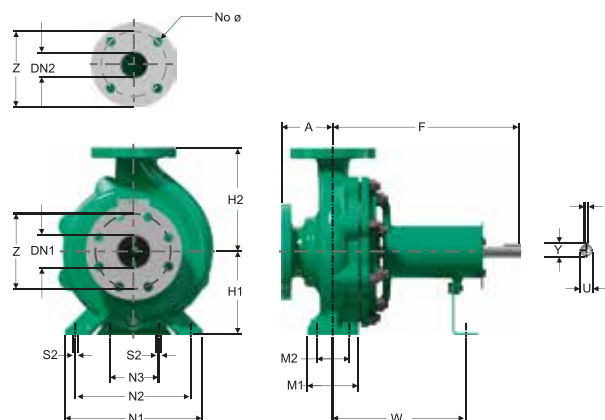

Dimensiones en milímetros

Fecha última revisión

2017-5-2