

Bombas IS Industrial Service

HIERRO

Acople Universal

IU 100X80X200



Características de la bomba

Tipo de bomba	Acoplamiento	Tipo de impulsor	Temperatura máx. líquido	Sello Mecánico	Velocidad (rpm)		
Centrifuga	Universal	Cerrado Balancado ISO (G 6.3)	90 °	1 3/4" Tipo 21	3600 rpm		
Modelo	Ref.	Ø Succión	Ø Descarga	H máx. (mca) *	Q máx. (gpm) **	Etapas	Peso Kg
IU 100x080x200	1K0420	100 mm	80 mm	85	969	1	68,1

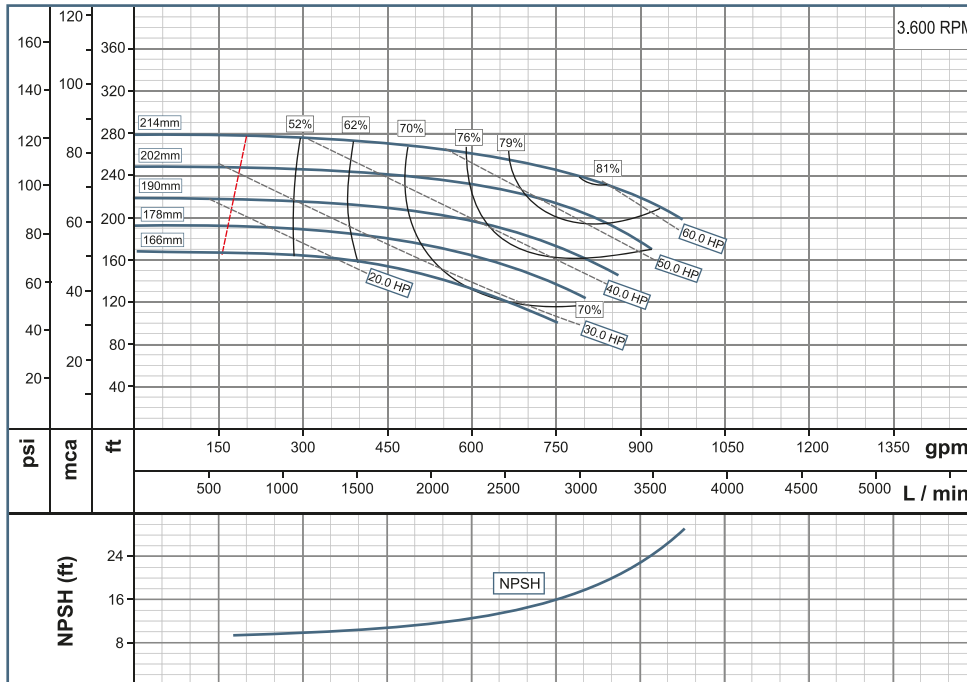

Aplicaciones

- * Suministro de Agua
- * Riego
- * Drenaje
- * Sistema de calentamiento
- * Sistema de Aire Condicionado
- * Servicio de agua
- * Agua Caliente

FLANGE		PUMP DIMENSIONS					SUPPORT DIMENSIONS					HOLES FOR		FLANGE DN1			FLANGE DN2			SHAFT END		
DN1	DN2	A	F	H1	H2	M1	M2	N1	N2	N3	W	S1	S2	Z	No	DIAM	Z	No	DIAM	U	X	Y
100	80	125	470	180	250	125	95	345	280	110	329,5	14	14	180	8	18	160	8	18	32	10	35

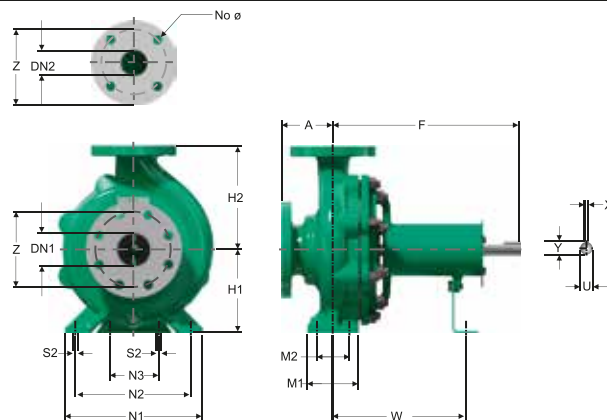

Dimensiones en milímetros

Fecha última revisión

2017-5-2