



# Bombas IS Industrial Service

## HIERRO

Acople universal

IU 065X050X200

### Características de la bomba

Tipo de bomba	Acoplamiento	Tipo de impulsor	Temperatura máx. líquido	Sello Mecánico	Velocidad (rpm)		
Centrífuga	Universal	Cerrado Balancado ISO (G.6.3)	90 °	1 1/4" Tipo 12	3600 rpm		
Modelo	Ref.	Ø Succión	Ø Descarga	H máx. (mca) *	Q máx. (gpm) **	Etapas	Peso Kg
IU 065x050x200	1K0411	65 mm	50 mm	90	484	1	48,4

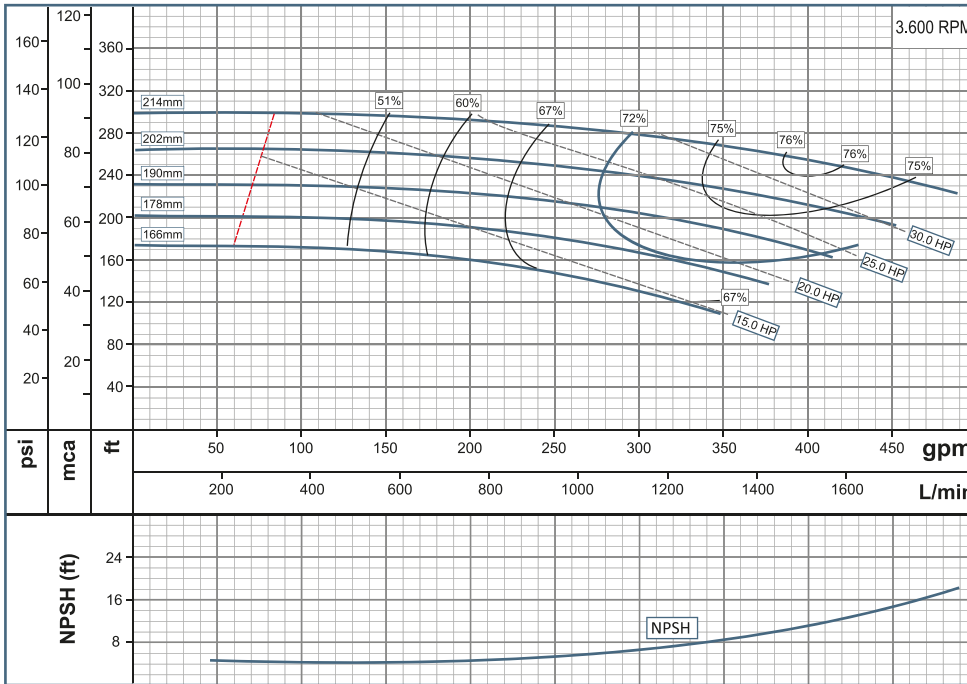

### Aplicaciones

- \* Suministro de Agua
- \* Riego
- \* Drenaje
- \* Sistema de calentamiento
- \* Sistema de Aire Condicionado
- \* Servicio de agua
- \* Agua Caliente

FLANGE		PUMP DIMENSIONS				SUPPORT DIMENSIONS					HOLES FOR		FLANGE DN1			FLANGE DN2			SHAFT END			
DN1	DN2	A	F	H1	H2	M1	M2	N1	N2	N3	W	S1	S2	Z	No	DIAM	Z	No	DIAM	U	X	Y
65	50	100	360	160	200	100	70	265	212	110	249,5	14	14	145	8	18	125	4	18	24	8	27

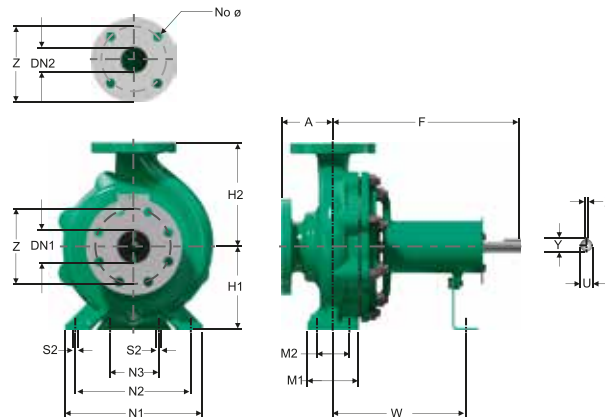

Dimensiones en milímetros

Fecha última revisión

2017-5-2