



Bombas IS Industrial Service HIERRO

Acople universal

IU 065x050x125

Características de la bomba

Tipo de bomba	Acoplamiento	Tipo de impulsor	Temperatura máx. líquido	Sello Mecánico	Velocidad (rpm)		
Centrífuga	Universal	Cerrado Balancado ISO (G.6.3)	90 °	1 1/4" Tipo 12	3600 rpm		
Modelo	Ref.	Ø Succión	Ø Descarga	H máx. (mca) *	Q máx. (gpm) **	Etapas	Peso Kg
IU 065x050x125	1K0409	65 mm	50 mm	39	339	1	38,0

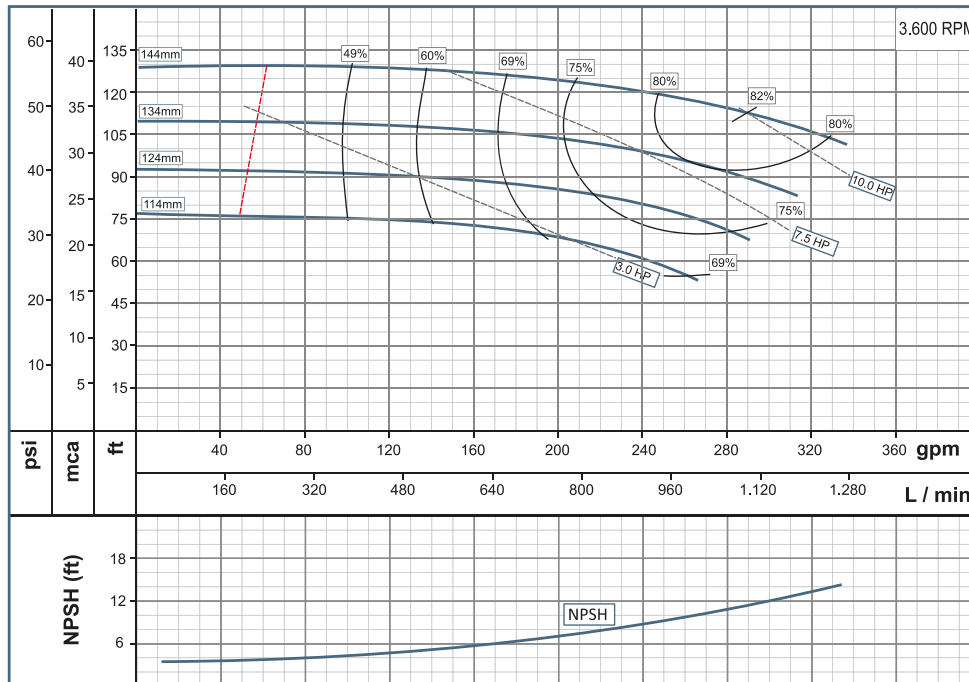

Aplicaciones

- * Suministro de Agua
- * Riego
- * Drenaje
- * Sistema de calentamiento
- * Sistema de Aire Condicionado
- * Servicio de agua
- * Agua Caliente

FLANGE		PUMP DIMENSIONS				SUPPORT DIMENSIONS					HOLES FOR		FLANGE DN1		FLANGE DN2			SHAFT END				
DN1	DN2	A	F	H1	H2	M1	M2	N1	N2	N3	W	S1	S2	Z	No	DIAM	Z	No	DIAM	U	X	Y
65	50	100	360	132	180	100	70	240	190	110	249,5	14	14	145	8	18	125	4	18	24	8	27

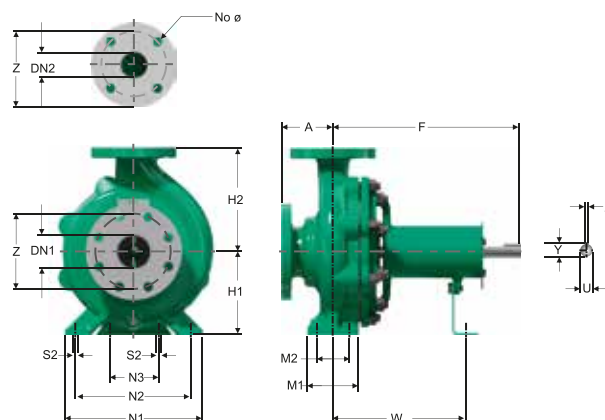

Dimensiones en milímetros

Fecha última revisión

2017-5-2